

# HED-300

TWO PANEL SYSTEM

## Assembly and Installation Instructions

Carefully select the location of your sign to be sure that it will be readily visible to those for which it is intended. Before installing any sign, be sure that the installation does not obstruct traffic or hamper local utilities, landscape, maintenance, snow-plowing, etc...

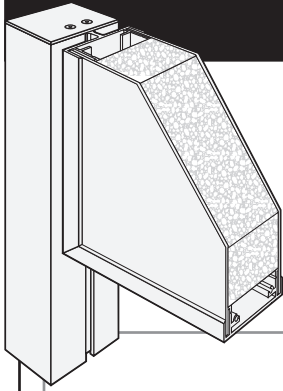

Double Post Mount

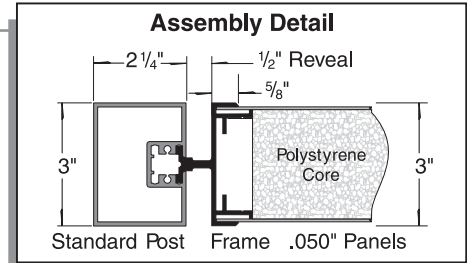

Note:  
Assembly is the same when optional post styles are used.

### Step 1

Carefully unpack the posts and frame assembly from the shipping cartons. Laying the posts on the ground (use shipping cartons underneath to avoid damage), slide the frame assembly into the appropriate post slots from the bottom until the frame is flush to the post caps, which are attached prior to shipping. Slide the locking squares into the post slots flush to the bottom of the frame and tighten in position using an allen wrench.

### Step 2

Laying the assembled sign on the ground as a guide, dig two 8" diameter x 30" deep holes; if the sign panel is 36" or higher, dig the holes 36" deep. Insert the sign posts into the holes and fill each hole with concrete. Level the sign both horizontally and vertically.

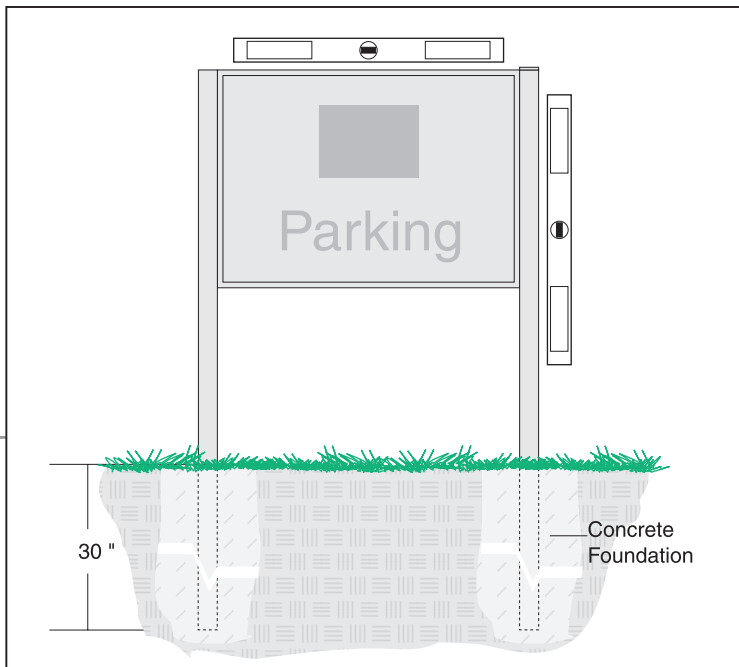
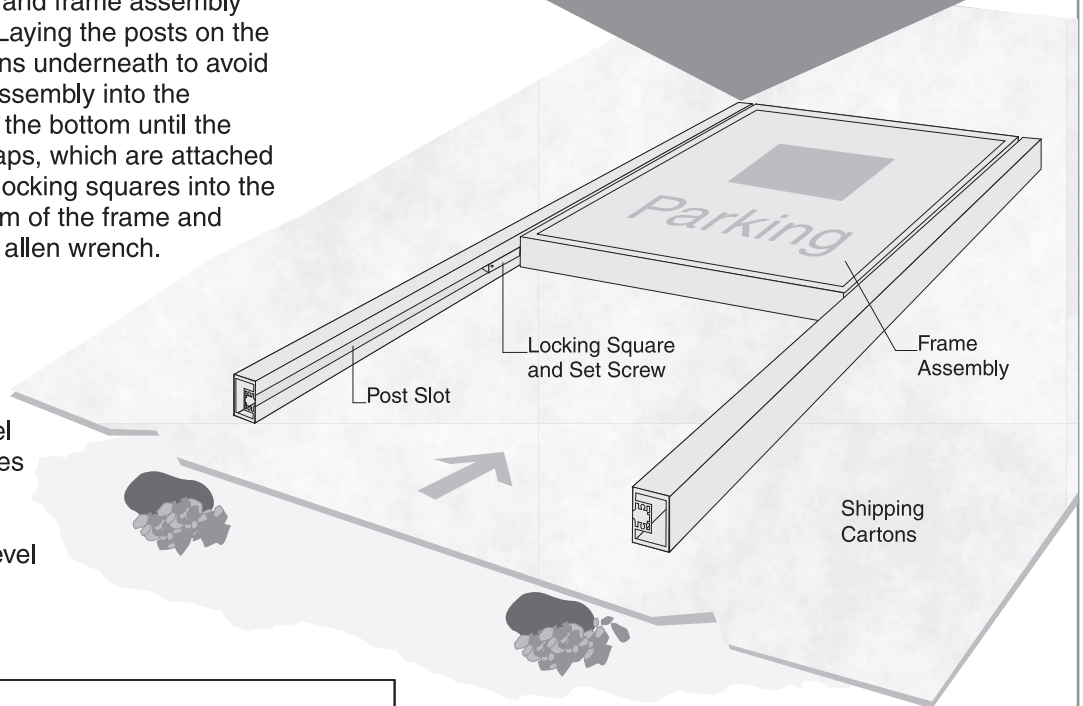

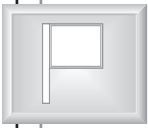

## Flag Mount

### Step 1

Carefully unpack the post from the shipping carton. Laying the post on the ground as a guide, (use the shipping carton underneath to avoid damage), dig a 8" diameter x 30" deep hole; if the sign panel is 36" or higher, dig the hole 36" deep. Insert the sign post into the hole, making sure the slot is in the correct position and fill the hole with concrete. Level the post both horizontally and vertically.

### Step 2

Once the concrete is set, unpack the frame assembly and slide it into the appropriate post slot until the top of the frame is level with the top of the post. Using an allen wrench, tighten the set screw or locking square to secure the frame in the post. To complete the assembly attach the post cap to the top of the post using the two screws supplied.

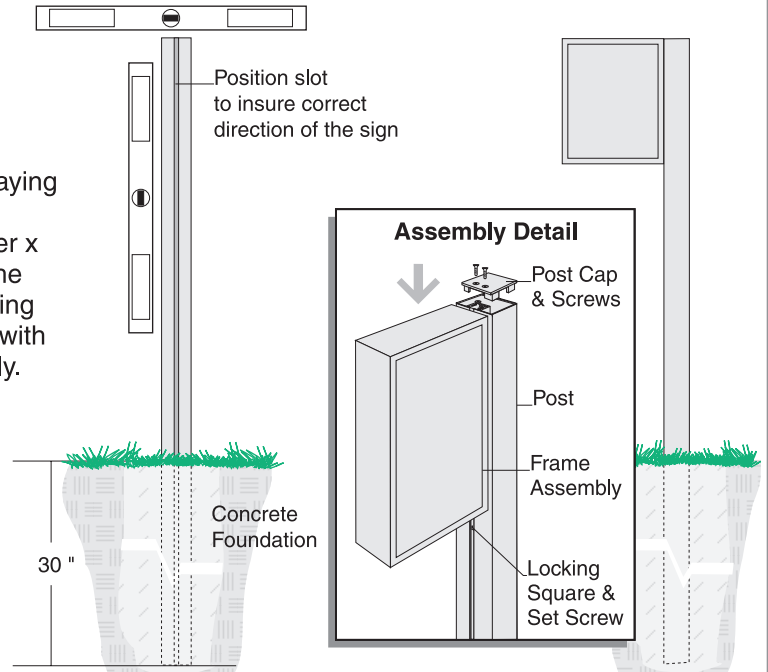

## Wall Mount

### Step 1

Carefully unpack the brackets & frame assembly from the shipping carton. Keeping in mind the clearances surrounding the sign, unfasten the appropriate corner screws and remove one frame section allowing for removal of the message panels and polystyrene core.

### Step 2

Locate the frame on the proper wall surface, level, mark and secure the top and bottom brackets to the wall with appropriate fasteners, not supplied. Attach the frame to the brackets, replace panels and core, attach the frame section with the corner screws removed in Step 1.

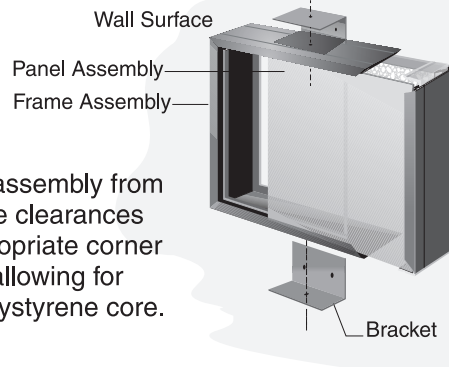

### Standard Face Assembly Detail

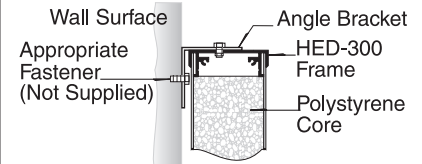

### Flush Face Assembly Detail

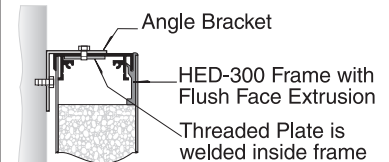

## Ceiling Mount

### Step 1

Carefully unpack the post and frame assembly from the shipping cartons. Secure the mounting post to the ceiling surface using appropriate fasteners, not supplied.

### Step 2

Slide the mounting frame of the assembled sign into the appropriate post slot and fasten post caps to both ends of the post using the supplied screws.

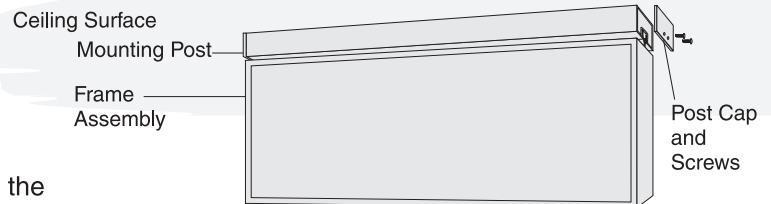

### Assembly Detail

